

FOGNATURA

IMHOFF JUMBO

Codice Fatturazione	Descrizione dei prodotti Dimensioni in cm. nominali						PREZZO DI LISTINO € CAD. ABITANTI SERVITI 	Caratteristiche e schemi tecnici
	It. tot.	It. sed.	It. dig.	alt/sp est.	Port. cop.	peso kg.cad		

Ø 234 interno

in cls vibrato armato



Fossa completa



C250



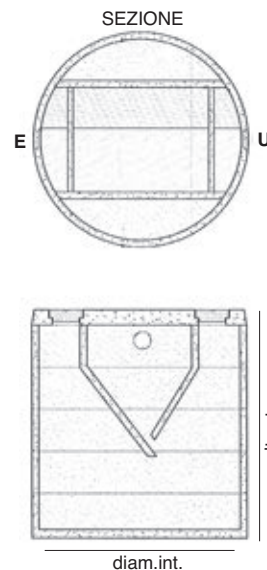

Fossa	6119 1491 4628 h	37 
con certificazione nazionale		
FOSSC1234	A+B+2C + Cop.rinf. 216 C250 6800	2.800,40
FOSSC6234	senza coperchio 200 5200	2.089,80
Elementi		
FOSS03234	Anello terminale A 50 800	378,00
sedimentatore senza lastre		
FOSS00234	Fondo monolit. B 50 1315	504,00
digestore		
FOSS05234	Anello prolunga C 50 800	377,00
vuoto		
FOSSL1234	Lastra curva grande 710	311,90
FOSSL1235	Lastra curva piccola 575	283,50
FOSSL1234	Paraschiuma 100	33,60
(2 per vasca)		
Coperchio nr.botole sp.		
FOSS06234	rinforzato 4 x 50x50 16 C250 1600	710,60



300 x 200 interno - giunto bicchiere

in cls vibrato armato



Fossa	12000 h	90 
con certificazione nazionale		
FOSSC1300	A+B+3C + Cop.rinf. 270 C250 13100	5.994,40
Fossa	h	110 
con certificazione nazionale		
FOSSC1310	A+B+4C + Cop.rinf. 320 C250 14600	6.620,60
Fossa	h	130 
con certificazione nazionale		
FOSSC1320	A+B+5C + Cop.rinf. 370 C250 16100	7.248,80
Fossa	h	150 
con certificazione nazionale		
FOSSC1330	A+B+6C + Cop.rinf. 420 C250 17600	7.878,00
Elementi		
FOSS03300	Anello terminale A 50 1500	628,30
sedimentatore senza lastre		
FOSS00300	Fondo monolit. B 50 3200	1.168,60
digestore		
FOSS05300	Anello vuoto C 50 1500	628,30
prolunga		
FOSSL1300	Kit lastra curva grande, curva piccola, 2 paraschiuma 1900	1.209,00
Coperchi nr.botole sp.		
FOSS06320	Rinforzato 4 x 45x45 16 C250 2000	1.100,90

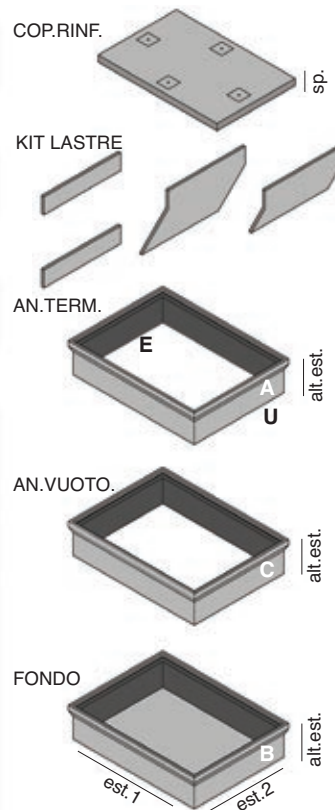

Identica classificazione consultabile nel Catalogo Web